



**ENTRE/MATIC**



# DYNACO M2 POWER

**Push-Pull**  
gear driven technology



**outside door**

[www.dynacodoor.com](http://www.dynacodoor.com)



# DYNACO M2 POWER

The Dynaco M2 Power is specifically designed for medium sized outside applications with intensive use. It protects your environments against wind, rain, snow, dirt and extreme temperatures.

Operating speed and perfect sealing properties improve your traffic flows and provide employee comfort, environmental control and savings on energy costs. Fully self-reinserting, the Dynaco M2 Power will automatically reinsert itself in its side guides when the curtain is accidentally hit.

- **HIGH SPEED OPERATION:**  
Up to 2,4 m/s, depending on the size.  
Closing speed 1,2 m/s.
- **PATENTED "PUSH PULL" TECHNOLOGY:**  
Unique door drive system.
- **SUPERIOR SEAL, WIND RESISTANT:**  
Patented side frame assembly. Neither blade nor brush systems. Up to wind load class 4.
- **CRASH FORGIVING AND SELF-REINSERTING WITHOUT INTERVENTION:**  
The curtain automatically reinserts itself when dislodged. No repair costs, no production downtime.
- **USER SAFETY:**  
Flexible curtain without rigid elements.
- **COMFORT OF USE:**  
DYNACO wireless detector at the bottom.
- **ADVANCED DRIVE:**  
Frequency driven motor and encoder for smooth operation. Wearable elements are reduced to a minimum.
- **DYNALOGIC CONTROL BOX:**  
User-friendly control box with self-diagnosis.
- **CONFORM TO EN13241-1**

Safe



"PUSH-PULL<sup>PT</sup>" drive technology

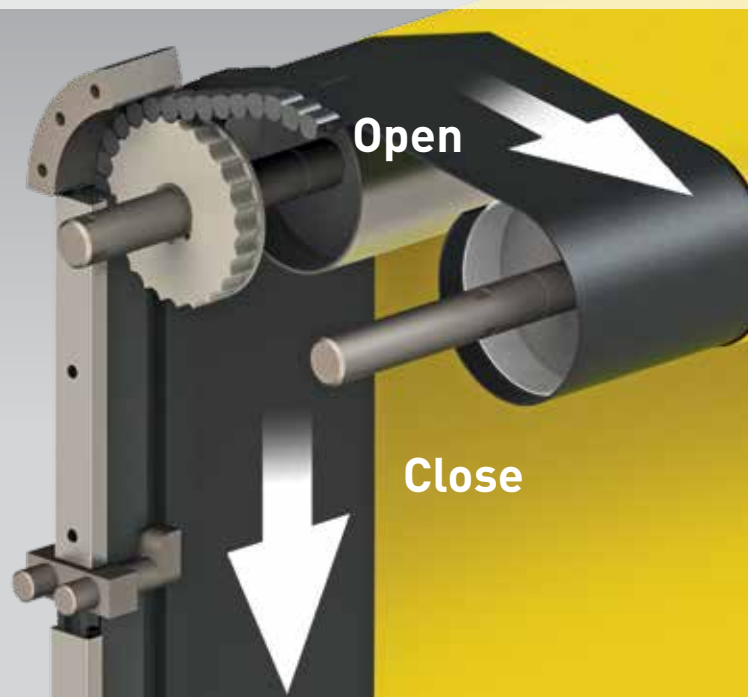



























### EN13241-1 STANDARDS

Standard	Ref.	Test acc.	Results
Water permeability	EN 12425	EN 12489	Class 2
Wind load	EN 12424	EN 12444	Class 3*
Wind permeability	EN 12426	EN 12427	Class 1**
Safe openings	EN 12453	EN 12445	Pass
Mechanical resistance	EN 12604	EN 12605	Pass
Unintended movements	EN 12604	EN 12605	Pass
Thermal transmittance	EN 12428	EN 12428	6,02 W/m <sup>2</sup> K
Performance (cycles)	EN 12604	EN 12605	1.000.000

\* The indicated class for wind resistance applies for maximum dimensions. For doors up to W 4.000mm x H 5.500mm: Class 4

\*\* Valid for a door of 3500 x 3500mm

### CHARACTERISTICS

<b>Max. dimensions</b>	W 5.500 mm x H 5.500 mm																
<b>Opening speed</b> <b>Closing speed</b>	Up to 2,4 m/s 1,2 m/s																
<b>Structure</b>	Galvanised steel: 80 x 40 x 3 mm. Option: stainless steel.																
<b>Drum</b>	Steel - Ø 102 x 2 mm.																
<b>Side guides</b>	Reinforced polyethylene (PE-UHMW1000) on springs. Lower 300 mm of side guides reinforced.																
<b>Motor</b>	4 poles, without brake. Power 1,5 kW IP rating: IP 65																
<b>Control box</b>	DYNALOGIC provided with: circuit breaker, general divider, adjustable timer, push button for opening and reset and emergency stop. IP rating: IP 54. Frequency inverter.																
<b>Standard detectors</b>	Infrared barrier: 300 mm from the floor. Wireless DYNACO detector (WDD).																
<b>Power supply</b> <b>Frequency</b>	Single phase 230V - 16 A Frequency: 50-60 Hz																
<b>Available colours</b> comparable with:	<table border="0"> <tbody> <tr> <td>Yellow RAL1003</td> <td></td> <td>Green RAL6005</td> <td></td> </tr> <tr> <td>Orange RAL2004</td> <td></td> <td>Grey RAL7035</td> <td></td> </tr> <tr> <td>Red RAL3000</td> <td></td> <td>White RAL9010</td> <td></td> </tr> <tr> <td>Blue RAL5002</td> <td></td> <td>Black RAL9005</td> <td></td> </tr> </tbody> </table>	Yellow RAL1003		Green RAL6005		Orange RAL2004		Grey RAL7035		Red RAL3000		White RAL9010		Blue RAL5002		Black RAL9005	
Yellow RAL1003		Green RAL6005															
Orange RAL2004		Grey RAL7035															
Red RAL3000		White RAL9010															
Blue RAL5002		Black RAL9005															
[Actual colours may deviate. Colour samples available upon request]																	

### Side reinforcement



### Side guide and lateral driving strap view

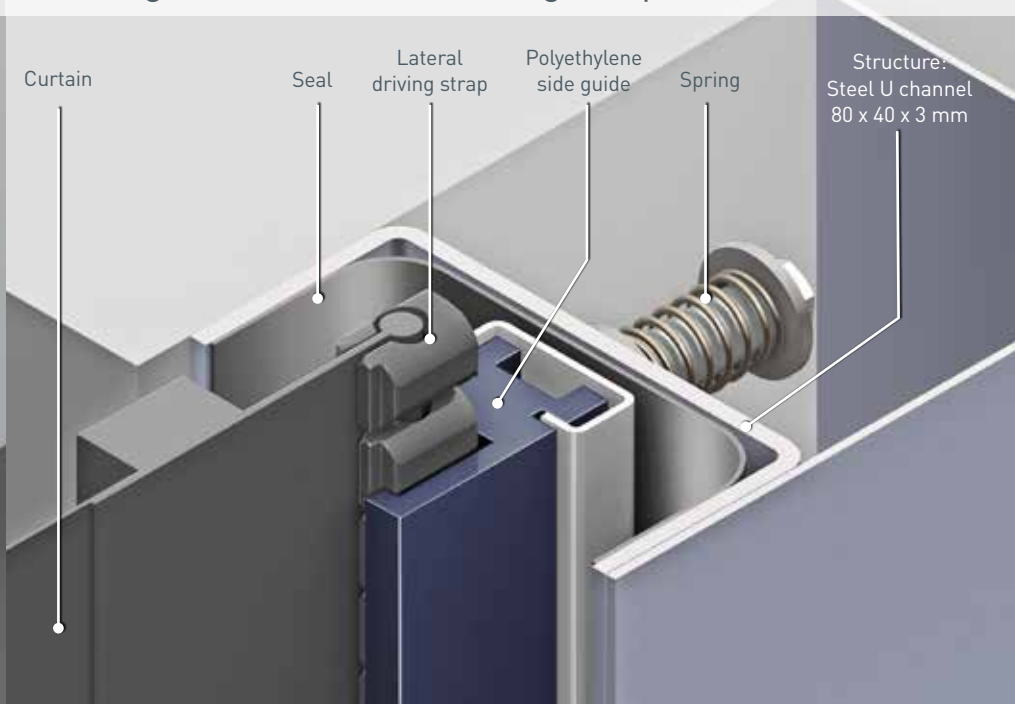

## Dimensions and installation requirements Dynaco M2 Power

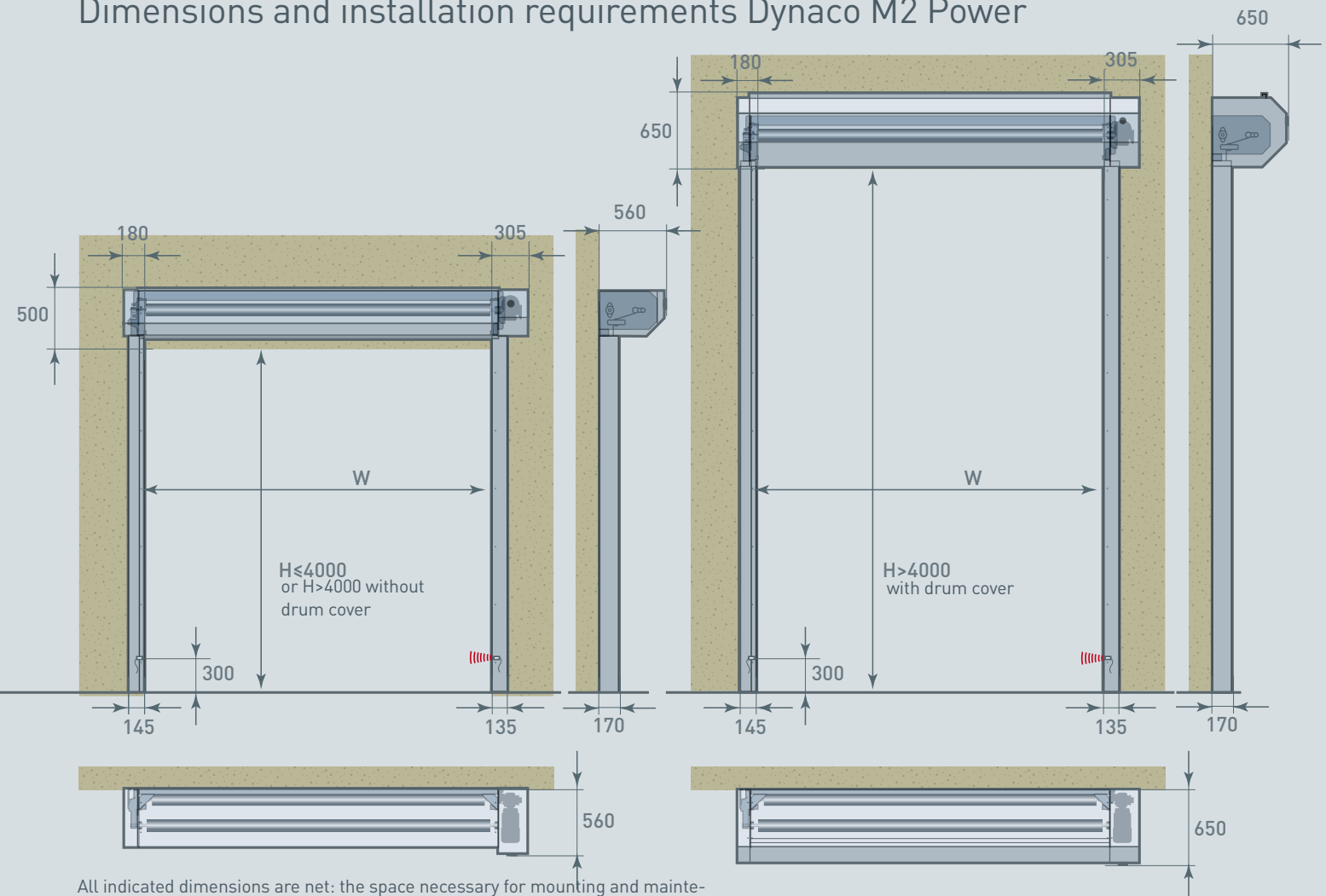

All indicated dimensions are net: the space necessary for mounting and maintenance has to be provided. Reduced dimensions: upon request.

REMARK: Based on the risk analysis of the environment, extra push buttons, detectors and covers might be required.

© Entrematic Group AB – 2018

Entrematic offers a comprehensive range of products for industrial, commercial, institutional and residential applications, including sectional doors, loading dock equipment, high-performance doors, residential garage doors, pedestrian doors, gates and barriers, and automation and operators. Built on nearly 200 years of accumulated expertise, Entrematic aims to be the most dynamic, innovative company in the entrance automation industry, and the best partner for dealers and installers. Our well-known brands include Normstahl, Dynaco, Ditec and EM.

Entrematic, Amarr, Kelly, Serco, Normstahl, Dynaco, Ditec and EM, as words and logotypes, are examples of trademarks owned by Entrematic Group AB or companies within the Entrematic Group.

The Dynaco products are protected by worldwide registered patents. As part of its policy of continuous product development, Entrematic Belgium NV reserves the right to change the characteristics of its products or components without prior notice.

Disclaimers:

For a correct use of our products, please refer to our manual. Everything that is mentioned in this brochure is only valid under the terms of use in the user manual and on condition that the door was properly installed and maintained and has not undergone abuse nor neglect.

ENTREMATIc BELGIUM NV  
 Waverstraat 21  
 B-9310 Moorsel-Aalst (Belgium)  
 Tel. +32 53 72 98 98  
 Fax. +32 53 72 98 50  
 info.dynaco.eu@entrematic.com  
 www.dynacodoor.com

**ENTREMATIc**